

LED Under Water

Installation, Use and Maintenance Guidelines

(Indicative for all luminaires in this series)



Note : Technical amendments reserved

Light Source : LED (Varied wattage Options)

Normal rated voltage for luminaire is 12Vdc (Ensure right power supply is given before turning the fixture on)

Application

High efficiency LED Underwater luminaire for illumination of medium & large swimming pools, water features and fountains revealing underwater architecture. Recessed and surface versions are available with different wattage & optics including RGB, creating special lighting effects.

Installation Recommendation

The main material of this product is 316 grade SS. This luminaire must only be operated under water. Recommended installation depth 400 to 800mm below water level. Temperature of water between -20°C - +40°C. Contact with construction steel must be avoided. The water must have neutral pH value and should be free from metal attacking ingredients. This product is suitable for underwater application only

For use only when immersed in water. Not suitable for submersion in sea water.

- Electronic equipment is sensitive to voltage surges. Hence it is recommended to install a stabilizer at source to ensure constant voltage power supply to all outdoor luminaires, for better performance and life span of the luminaire and to avoid risk of damage.
- Installation and maintenance of the luminaire should be carried out by qualified person only, in accordance with good electrical practice and appropriate accessories.
- Maximum 40 feet distance from the fitting to the remote power supply for monochromatic version. Consider the length of the cable left in the recessed box to calculate the distance.
- The minimum distance of the remote junction box from the water must be always verified and in compliance to the norms.
- The cable connected with the luminaire should not be cut below 1m length and ensure that the connection to the power line is done correctly with use of IP67 connectors outside the waterbody
- If the cable supplied with the luminaire is not sufficient to reach the required safety distances or safety zones, it is necessary to install an additional remote junction box.
- Sufficient cable must be left inside the recess box in order to allow the complete extraction from the water of the luminaire for maintenance operation.
- The IP rating of the connector between fixture and main cable must be equal to or greater than the IP rating of the Luminaire.
- Requires remote power supply (12Vdc)
- It is very important to follow these instructions to enable the luminaire to be installed correctly. Failure to follow this will void all warranty on the product.

- Please retain installation guidelines for future reference.

This is a 12Vdc product, and the product should be connected using an appropriate power source

Technical Specifications

- Luminaire housing and front cover made of stainless steel of grade 316
- Clear tempered safety glass.
- EPDM gasket
- 3 metres connecting power cable HO7RN-F 2x1.0mm
- Mounting sleeve
- PG-11 copper with nickel coated cable gland
- Mechanical resistance (Review datasheet)
- Protection class IP68
- Maximum immersion depth 1metre
- CE - Conformity mark

Light distribution

Luminaire photometric data / IES files for the light planning program DIALux can be downloaded in IES-format on the KLITE web page www.klite.in.

Safety

- For Safety, always ensure power supply is disconnected before regular maintenance, lamp replacement and accessory fitting.
- Installation and operation of this luminaire are subject to national safety regulations. The manufacturer is discharged from liability when damage is caused by improper use or installation.
- Any modification of this luminaire is forbidden without authorization. If any luminaire is subsequently modified, the persons responsible for the modification shall be considered as the manufacturer.
- Do not subject the product for voltage or current which is not rated for.

Installation

- The luminaire must only be operated with the complete protective cover.
- The luminaire must not permanently get in contact with aggressive media that might corrode the housing of the luminaire.
- The recessed housing of the underwater luminaire is casted-in while the pool is being made. Calibrate recessed housing. The recessed housing is fixed with screws onto the shuttering with the cable entry upwards.
- Clamp the PVC hose to the recessed housing. The PVC hose must be led in such a way that the connecting cable can be inserted and that no self-emptying of the pool can occur.
- Lead cable through the screw gland and PVC hose. As maintenance work is carried out above the water surface provide a suitable cable length. Tighten the screw cable gland
- Do not open the front plate of light output opening of LED directly during installation.
- Please ensure that the wires are connected to the right polarity [Phase, Neutral & Earth] and the luminaire must be earthed (Class 1).
- Insert luminaire into the mounting plate and fix with non-corrosive stainless steel screws.
- Lock and unlock the screws following an alternative sequence, tightening all screws evenly.

Important Note :

- LEDs are highly sensitive electronic components. Please avoid touching the light source directly, during installation.
- If fixture is supplied with integrated LED module, **Do Not Open** the front plate of luminaire during installation. Warranty void if the LED compartment is opened

Cleaning and care

- After installation, the luminaire should first be cleaned.
- Building dust, residues from pressure-sensitive adhesives, paint splatter and rust film must be completely removed. Never use cleaning implements made of normal steel, steel brushes or steel wool because they cause extraneous rust to form.
- Cleaning agents containing hydrochloric acid and chlorides should never be used.
- We recommend cleaning the luminaires regularly.

Maintenance Recommendations

- A scheduled maintenance program must be carried out on the Installation and fixtures regardless of the IP rating or application
- Disconnect the electrical installation before maintenance operation
- The LED module contained in this luminaire shall only be replaced by the manufacturer. For further informations, please contact your supplier.
- To maintain the surface of the luminaire, soilings and foulings on the stainless steel parts should be removed frequently. They can be removed with suitable stainless steel cleaners. Do not use high pressure cleaners.

Storage

If site is not ready for installation, store the material in proper warehouse facilities. K-Lite is not responsible for the damages caused due to the mishandling of material at site.

Important Note

To ensure proper installation, kindly translate / communicate the installation instructions to the local qualified electrician in their respective local language.

Please Recycle

The electronic components of this product should not be disposed via the normal waste system. To prevent possible harm to the environment and Human health please ensure that the product is recycled in an environmentally sound manner. Please contact your local collection facilities for more details.

Customer Service

If Klite agrees to receive back some fixtures for Lab Testing and further analysis please ensure that the fixtures shipped should NOT BE DISASSEMBLED. Disconnect the power line and ship the product as it is, unless otherwise specified.

Please contact customercare@klite.in for more information.

Wiring Diagram

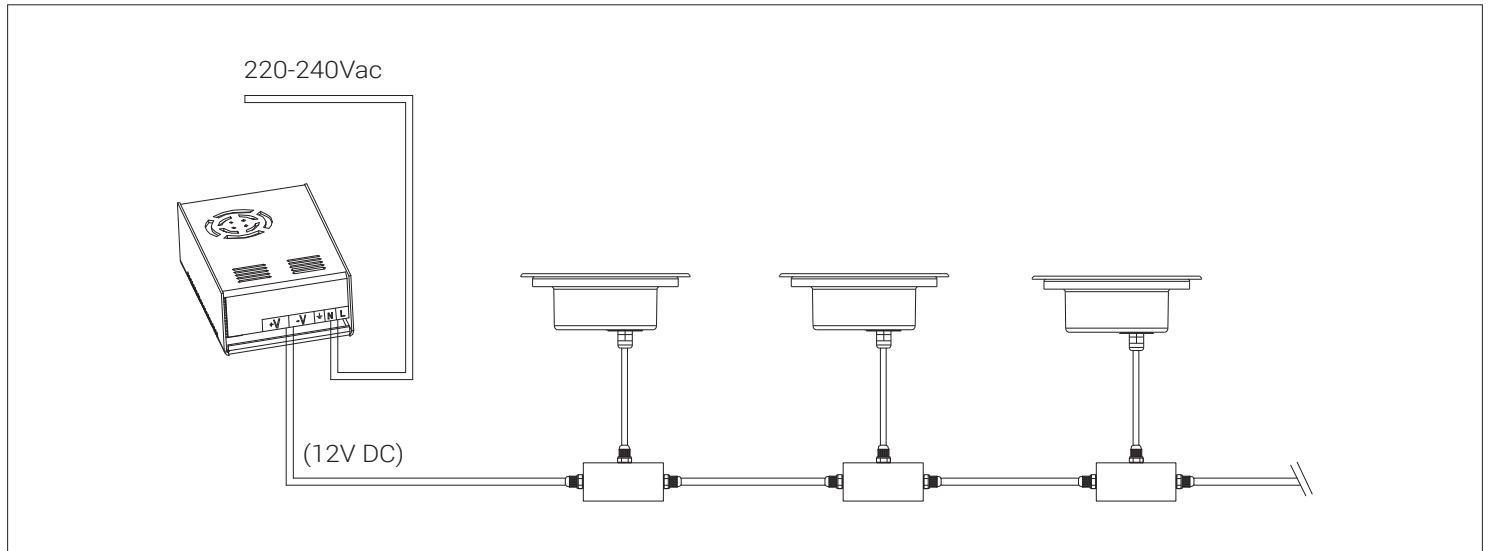

Connectors



1

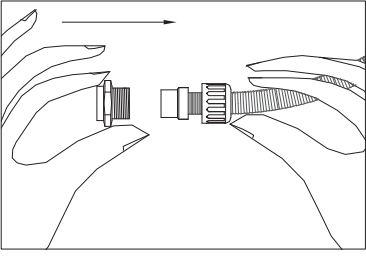

- Put the wave tube through the nut and the rubber plug (The wave tube should reach the bottom of the rubber plug)
- Fasten the nut with the screw by using a tool

2

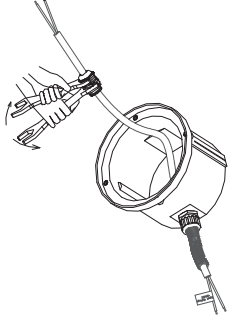

- Put the cable through the wave tube and the hole of the mounting sleeve from outside.
- Then insert the cable into the nut/rubber plug and the screw of the gland.
- Fix the nut with screw of the gland tightly.

3

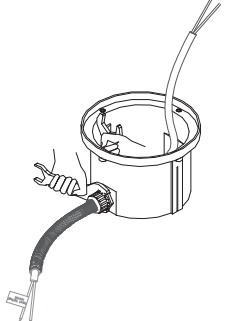

- Screw the gland with the connector on the wave tube tightly with two wrenches.
- Fix the backcover to the mounting sleeve by four screws.

4

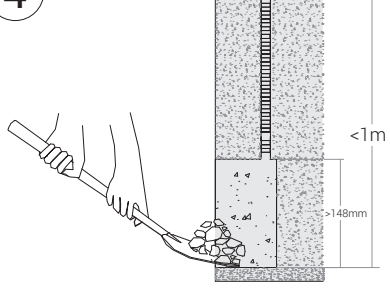

- Fix the two type "L" bracket on the mounting sleeve.
- The distance between these installation and the ground should be less than 1m.

5

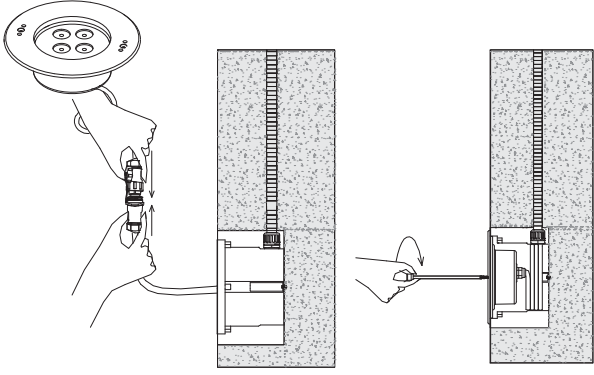

- Connect the lighting fixture with the power cable by IP68 connector.
- Turn on the power to make sure it is working & fix the luminaire on to the mounting sleeve.

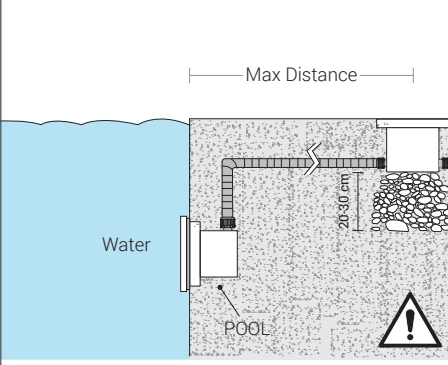

Maximum distance from the fitting to the remote power supply
 For monochromatic version - 40 mts.
 For RGBW version - 15 mts.
 ⚠ Consider the length of the cable left in the recessed box to calculate the distance

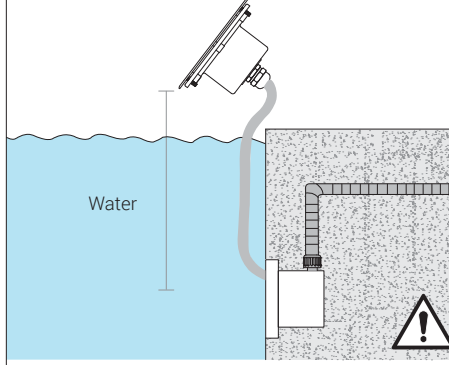

Sufficient cable must be left inside the recess box in order to allow the complete extraction from the water of the fitting for maintenance operation.

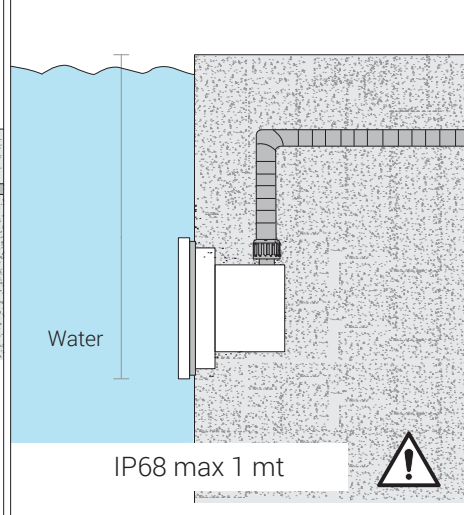

IP68 max 1 mt